

CODE NUMBER

3362156IN

DESCRIPTION

Battery Power Supply, Mixer Not Included, Polished Chrome Finish, 0.5 gpm, Multi-Laminar Spray, Infrared Sensor, Sloan® Battery-Powered Deck-Mounted Mid Body Faucet.

DETAILS

- Flow Rate: 0.5 gpm (2 Lpm) (0.5GPM)
- Spray Type: Multi-Laminar (MLM)
- Sensor Type: Infrared (IR)
- Mounting Type: Single Hole ()
- Power Supply: Battery (BAT)
- Temperature Mixer: Mixer Not Included ()
- Finish: Polished Chrome (CP)
- Factory Default Timeout: 30s
- Factory Default GPC: 0.25

FEATURES

Commercial Grade, ADA Compliant, Electronic, Sensor-Activated, Brass Pedestal Hand Washing Faucet with the following features:

- Adjustable Infrared Sensor Range
- 36" (914 mm) Long Sensor Cable
- 24" (610 mm) Long Flex Hose
- Filtered Solenoid Valve with serviceable Strainer Filter
- Includes Four (4) AA-size Batteries
- Includes appropriate Mounting Hardware

ELECTRICAL SPECIFICATIONS

- Battery Life: 2 years 8,000 cycles/month
- Sensor Range: 4" - 7" (102 - 178mm)
- Timeout Adjustment Settings: 30s

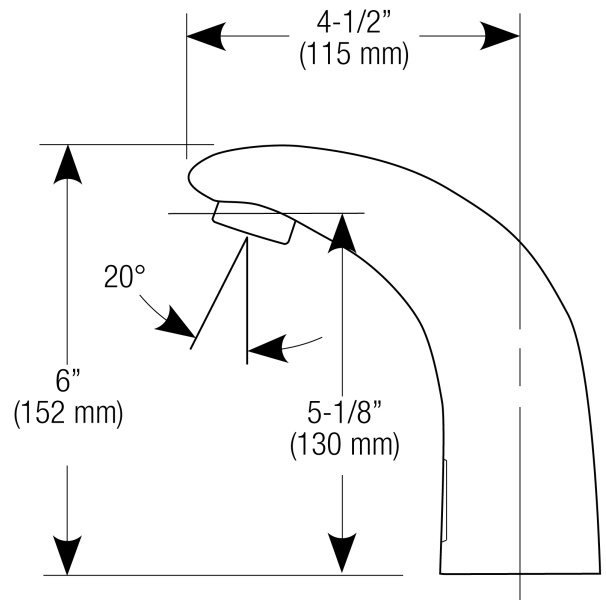

NOTES

All information contained within this document subject to change without notice.

Looking for other variations of the SF-2450 product? [View the general spec sheet with all options.](#)

[Find a matching soap dispenser](#) for this faucet.

[Find a compatible sink](#) for this faucet.

WARRANTY

1 Year

ROUGH-IN

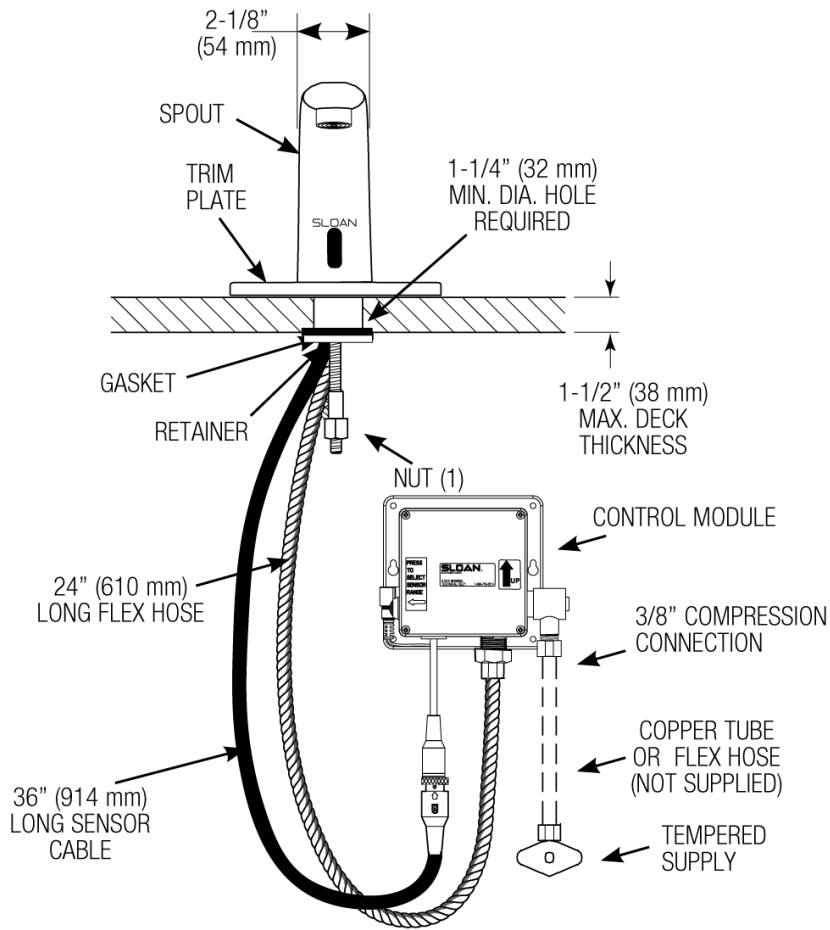

**HOT AND COLD WATER
SUPPLY APPLICATIONS**
(SPECIFY IN MODEL VARIATION)

